

TVG

- Termosigillatrici carrellate
- Thermosealing machines on wheels
- Operculeuses sur chariot
- Fahrbare Thermoschweißgeräte



VALKO®

vacuum packaging technology

made in Italy

TVG

Mod.
TVG-SAP



La termosigillatrice semiautomatica pneumatica TVG-SAP, carrellata su ruote, è ideale per le più svariate esigenze di confezionamento di vaschette di varie misure. Dispone di vari optional che completano e soddisfano qualsiasi richiesta.

CARATTERISTICHE

- Costruita in acciaio inox e alluminio
- Caricamento e passaggio film bobina protetto igienicamente
- Partenza automatica ciclo
- Facile e rapida sostituzione della piastra saldante

The semiautomatic pneumatic thermosealing machine on wheels TVG-SAP is the most ideal machine to satisfy the several packaging requirements of different sizes of containers. This machine can be equipped with different optional which complete and satisfy any request.

SPECIFICATIONS

- Built in stainless steel and in aluminium
- Loading and passage of the film spool hygienically protected
- Automatic start of the cycle
- Easy and rapid change of the sealing plate

L'operculeuse semi-automatique pneumatique sur chariot TVG-SAP est idéale pour les différentes exigences d'emballage des barquettes aux dimensions variées. Elle dispose de diverses options qui complètent et satisfont n'importe quelle demande.

CARACTERISTIQUES

- Construite en acier inox et aluminium
- Chargement et passage bobine du film protégés hygiéniquement
- Départ automatique du cycle
- Changement de la plaque de chauffe facile et rapide

Das fahrbare halbautomatische und pneumatische Thermoerschweißgerät TVG-SAP ist die ideale Maschine für die unterschiedlichen Anforderungen für die Verpackung von Schalen verschiedener Größen. Das zusätzlich erhältliche Zubehör komplettiert diese Serie und bietet somit Lösungen an, die jeglichen Ansprüchen genügen.

PRODUKTDDETAILS

- Aus rostfreiem Stahl und Aluminium gebaut
- Ladung und Durchgang der Folie hygienisch geschützt
- Automatischer Start des Zyklus
- Leichter und schneller Austausch der Schweißplatte

Mod.

TVG 20

TVG 25

TVG 40

TVG 60



Le termosigillatrici sottovuoto in atmosfera protetta serie TVG, carrellate su ruote, sono ideali per le più svariate esigenze di confezionamento sottovuoto di vaschette di varie misure, dispongono di vari optional che completano e soddisfano qualsiasi richiesta.

CARATTERISTICHE

- Costruita in acciaio inox e alluminio
- Caricamento e passaggio film bobina protetto igienicamente
- Partenza automatica ciclo
- Facile e rapida sostituzione della piastra saldante
- N. 3 riduttori di volume in dotazione

The vacuum thermo-sealing machines TVG series on wheels, are the most ideal machines to satisfy the several vacuum packaging requirements of different sizes of containers and can be equipped with different optional which complete and satisfy any request.

SPECIFICATIONS

- Built in stainless steel and in aluminium
- Loading and passage of the film spool hygienically protected
- Automatic start of the cycle
- Easy and rapid change of the sealing plate
- No. 3 volume reducers

Les operculeuses sous vide et sous atmosphère protectrice sur chariot, série TVG, sont idéales pour les différentes exigences d'emballage sous vide de barquettes aux dimensions variées. Elles disposent de diverses options qui complètent et satisfont n'importe quelle demande.

CARACTERISTIQUES

- Construite en acier inox et aluminium
- Chargement et passage bobine du film protégés hygiéniquement
- Départ automatique du cycle
- Changement de la plaque de chauffe facile et rapide
- 3 réducteurs de volume en polyéthylène

Die fahrbaren Vakuum-Thermoschweißgeräte Serie TVG sind die idealen Maschinen für die unterschiedlichen Anforderungen für die Verpackung von Schalen verschiedener Größen. Das zusätzlich erhältliche Zubehör komplettiert diese Serie und bietet somit Lösungen an, die jeglichen Ansprüchen genügen.

PRODUKTDETAILS

- Aus rostfreiem Stahl und Aluminium gebaut
- Ladung und Durchgang der Folie hygienisch geschützt
- Automatischer Start des Zyklus
- Leichter und schneller Austausch der Schweißplatte
- 3 Polythen-Platten

TVG

Optionals



- Piastra saldante universale con lame di taglio anteriore e posteriore
- Universal sealing plate with front and back cutting edges
- Plaque de chauffe universelle avec lames antérieure et postérieure
- Universale Schweißplatte mit vorderer und hinterer Klinge



- Stampo doppia impronta per piatto 180x180 mm x 2
- Double die for standard tray 180x180 mm x 2
- Outillage à double empreinte pour barquettes 180x180 mm x 2
- Werkzeug doppelte Aufnahme für Teller 180x180 mm x 2



- Stampo 4 impronte per vaschette GN 1/8 x 4 (160x130 mm x 4)
- Die 4 impression for trays GN 1/8 x 4 (160x130 mm x 4)
- Outillage 4 empreintes pour barquettes GN 1/8 x 4 (160x130 mm x 4)
- Werkzeug 4 Aufnahmen für Schalen GN 1/8 x 4 (160x130 mm x 4)



- Stampo doppia impronta per vaschette GN 1/4 x 2 (160x260 mm x 2)
- Die double impression for trays GN 1/4 x 2 (160x260 mm x 2)
- Outillage à double empreinte pour barquettes GN 1/4 x 2 (160x260 mm x 2)
- Werkzeug doppelte Aufnahme für Schalen GN 1/4 x 2 (160x260 mm x 2)



- Stampo singola impronta per vaschette GN 1/2 (260x315 mm)
- Die single impression for trays GN 1/2 (260x315 mm)
- Outillage à empreinte unique pour barquettes GN 1/2 (260x315 mm)
- Werkzeug einfache Aufnahme für Schalen GN 1/2 (260x315 mm)

- A richiesta si possono avere impronte di varie forme e dimensioni
- On request it is possible to get dies of different forms and sizes
- Sur demande il est possible d'avoir des empreintes de formes et dimensions diverses
- Auf Anfrage sind Werkzeuge von verschiedenen Formen und Grössen erhältlich

Optionals



- Piastra saldante con fustellatura + stampo doppia impronta per piatto 180x180 mm x 2 (è necessario utilizzare il recupero automatico scarto film)
- Sealing plate with profile cut and die double impression for tray 180x180 mm x 2 (Only with automatic film waste collection)
- Plaque de chauffe avec coupe aux contours + outillage à double empreinte pour barquette 180x180mm x 2 (Il faut utiliser la récupération automatique des chutes de film)
- Schweißplatte mit Schneidevorrichtung + Werkzeug doppelte Aufnahme für Teller 180x180 mm x 2 (Nur mit automatischer Sammlung des Folienausschusses möglich)



- Piastra saldante con fustellatura + stampo 4 impronte per vaschette GN 1/8 x 4
- Sealing plate with profile cut and die 4 impression for trays GN 1/8 x 4
- Plaque de chauffe avec coupe aux contours + outillage à 4 empreintes pour barquettes GN 1/8 x 4
- Schweißplatte mit Schneidevorrichtung + Werkzeug 4 Aufnahmen für Schalen GN 1/8 x 4



- Piastra saldante con fustellatura + stampo doppia impronta per vaschette GN 1/4 x 2
- Sealing plate with profile cut and die double impression for trays GN 1/4 x 2
- Plaque de chauffe avec coupe aux contours + outillage à double empreinte pour barquettes GN 1/4 x 2
- Schweißplatte mit Schneidevorrichtung + Werkzeug doppelte Aufnahme für Schalen GN 1/4 x 2



- Piastra saldante con fustellatura + stampo singola impronta per vaschette GN 1/2
- Sealing plate with profile cut and die single impression for trays GN 1/2
- Plaque de chauffe avec coupe aux contours+ outillage à empreinte unique pour barquettes GN 1/2
- Schweißplatte mit Schneidevorrichtung + Werkzeugeinfache Aufnahme für Schalen GN 1/2

- A richiesta è possibile avere la fustellatura di stampi speciali
- Customized profile cut for dies available on request
- Sur demande il est possible d'avoir des coupes aux contours d'outillages spécifiques
- Auf Anfrage wird die Folien-Schneidevorrichtung für kundenspezifische Werkzeuge angefertigt

TVG

Optionals



- Automazione per cassetto
- Automatic drawer
- Tiroir automatique
- Automatische Schublade



- Recupero automatico scarto film
- Automatic film waste rewind
- Récupération automatique des chutes de film
- Automatische Sammlung des Folienausschlusses



- Compressore d'aria silenzioso con serbatoio d'accumulo integrato nella termosigillatrice (modello da 5 litri)
- Silent compressed air generator with air tank housed in the machine body (5 lt. model)
- Compresseur silencieux avec réservoir intégré dans la machine (modèle à 5 lt.)
- Schallgedämpfter Luftkompressor mit Luftspeicher im Gerät integriert (5 Lt. Modell)



- Compressore d'aria silenzioso con serbatoio d'accumulo (modello da 9 litri)
- Silent compressed air generator with air tank (9 lt. model)
- Compresseur silencieux avec réservoir (modèle à 9 lt.)
- Schallgedämpfter Luftkompressor mit Luftspeicher (9 Lt. Modell)

Optionals TVG20 - TVG25 - TVG40 - TVG60



- Valvola di blocco per miscele ad alto contenuto di ossigeno ($O_2 > 21\%$)
- Safety vane for high oxygen ($O_2 > 21\%$) gas mixtures
- Electrovanne de sécurité à oxygène ($O_2 > 21\%$)
- Sicherheitsabsperventil für Gasmischungen mit hohem Oxygeengehalt ($O_2 > 21\%$)
- Dispositivo per gradualizzazione vuoto (STOP & GO)
- STOP & GO gradual vacuum system
- Dispositif pour graduer le vide (STOP & GO)
- STOP & GO graduelles Vakuuum-System













- Facile e rapida sostituzione della piastra saldante
- Easy and rapid change of the sealing plate
- Changement de la plaque de chauffe facile et rapide
- Leichter und schneller Austausch der Schweißplatte

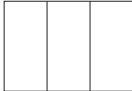
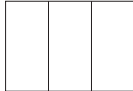

TVG 20 - TVG 25 - TVG 40 - TVG 60

- Vasca stampata in acciaio inox per una facile pulizia, che permette di utilizzare stampi con fustellatura **320 x 265 mm (1/2 GN)** come pure **4 x GN 1/8**
- The stainless steel chamber, pressed for an easy cleaning, allows the use of dies with profile cut of max. **320 x 265 mm (1/2 GN)** and of **4 x GN 1/8**
- La cuve en acier inox, emboutie pour un nettoyage facile, permet d'utiliser outillages avec système de coupage à ras bords des barquettes **320 x 265 mm (1/2 GN)** et **4 x GN 1/8** aussi
- Die Kammer aus rostfreiem Stahl, tiefgezogen, leicht zu reinigen, ermöglicht es, Werkzeuge mit max. Größen von **320 x 265 mm (1/2 GN)** so wie **4 x GN 1/8** zu siegeln

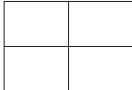
CONFIGURAZIONE STAMPI - MOULDS CONFIGURATION - CONFIGURATION DES MOULES -KONFIGURATION DER NUETZEN

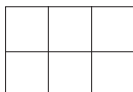
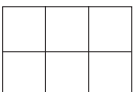
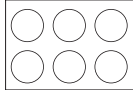
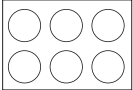
Impronte Impressions Empreintes Nutzen	Senza fustellatura Without profile cut Sans coupe autour Ohne Konturschneidung	Con fustellatura (con recupero sfrido) With profile cut (with automatic film waste collection) Avec coupe autour (avec récupération automatique des chutes de film) Mit Konturschneidung (Mit automatische Foliensammlung)	Con fustellatura (senza recupero sfrido) With profile cut (without automatic film waste collection) Avec coupe autour (sans récupération automatique des chutes de film) Mit Konturschneidung (Ohne automatische Foliensammlung)
1	 360x280 mm	 350x275 mm	 340x275 mm
2	 280x180 mm	 275x180 mm	 165x275 mm
3	 115x280 mm	 275x100 mm	 100x275 mm
4	 130x175 mm	 175x130 mm	 165x130 mm
6		 95x95 mm	 95x95 mm
		 ø 95 mm	 ø 95 mm

IMPORTANTE

- L'altezza massima possibile delle vaschette è di 115 mm
- Tutte le grandezze sono indicate in mm (millimetri) e sono intese come dimensioni massime possibili
- Ogni tipo di stampo può essere confermato solo dopo la visione di una campionatura di vaschette
- Ulteriori tipi di stampi sono possibili su richiesta

IMPORTANT

- The maximal height of the trays can be 115 mm
- All sizes are indicated in mm (millimetres) and are intended as maximum sizes possible
- Each type of mould can be confirmed only after having received some samples of trays
- Additional types of moulds are available on request

ATTENTION











- La hauteur maximale des barquettes peut être de 115 mm
- Toutes les dimensions sont indiqués en mm (millimètres) et ce sont les tailles maximales possibles
- Chaque type de moule peut être confirmé seulement après avoir reçu les échantillons
- D'autres types de moules sont disponibles sur demande

ZU BEACHTEN

- Maximale Höhe der Schalen ist 115 mm
- Alle Größen sind in mm (Millimeter) angegeben und sind die maximalen möglichen Größen
- Jede Art von Nutzen kann erst nach Betrachten des Ausfallmusters der Schalen bestätigt werden
- Andere Nutzen sind auf Anfrage erhältlich

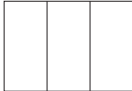
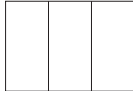
TVG 20 - 25 - 40 - 60

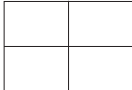
CONFIGURAZIONE STAMPI - MOULDS CONFIGURATION - CONFIGURATION DES MOULES -KONFIGURATION DER NUETZEN

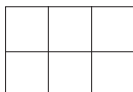
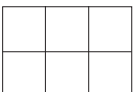
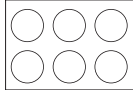
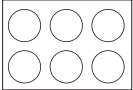
Impronte Impressions Empreintes Nutzen	Senza fustellatura Without profile cut Sans coupe autour Ohne Konturschneidung	Con fustellatura (con recupero sfrido) With profile cut (with automatic film waste collection) Avec coupe autour (avec récupération automatique des chutes de film) Mit Konturschneidung (Mit automatische Foliensammlung)	Con fustellatura (senza recupero sfrido) With profile cut (without automatic film waste collection) Avec coupe autour (sans récupération automatique des chutes de film) Mit Konturschneidung (Ohne automatische Foliensammlung)
1	 360x280 mm	 350x275 mm	 340x275 mm
2	 280x180 mm	 275x180 mm	 165x275 mm
3	 115x280 mm	 275x100 mm	 100x275 mm
4	 130x175 mm	 175x130 mm	 165x130 mm
6		 95x95 mm	 95x95 mm
		 ø 95 mm	 ø 95 mm

IMPORTANTE

- L'altezza massima possibile delle vaschette è di 115 mm
- Tutte le grandezze sono indicate in mm (millimetri) e sono intese come dimensioni massime possibili
- Ogni tipo di stampo può essere confermato solo dopo la visione di una campionatura di vaschette
- Ulteriori tipi di stampi sono possibili su richiesta

IMPORTANT

- The maximal height of the trays can be 115 mm
- All sizes are indicated in mm (millimetres) and are intended as maximum sizes possible
- Each type of mould can be confirmed only after having received some samples of trays
- Additional types of moulds are available on request

ATTENTION

- La hauteur maximale des barquettes peut être de 115 mm
- Toutes les dimensions sont indiqués en mm (millimètres) et ce sont les tailles maximales possibles
- Chaque type de moule peut être confirmé seulement après avoir reçu les échantillons
- D'autres types de moules sont disponibles sur demande

ZU BEACHTEN

- Maximale Höhe der Schalen ist 115 mm
- Alle Größen sind in mm (Millimeter) angegeben und sind die maximalen möglichen Größen
- Jede Art von Nutzen kann erst nach Betrachten des Ausfallmusters der Schalen bestätigt werden
- Andere Nutzen sind auf Anfrage erhältlich

TVG



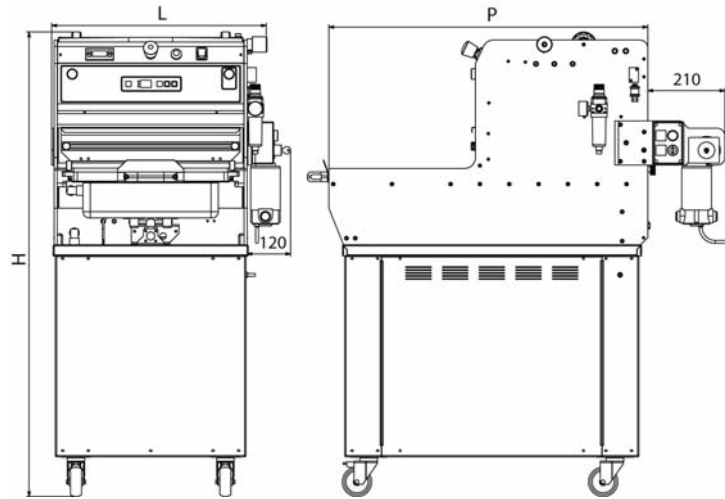

TECHNICAL INFO

Modello Model Modèle Modell	Larghezza Width Largeur Breite	Profondità Depth Profondeur Tiefe	Altezza Height Hauteur Höhe	Impronta max. stampo Max. impression of the die Empreinte max. sur l'outillage Max. Abdruck Siegelform	Altezza max. vaschetta Max. height of the cup Hauteur max. de la barquette Max. Höhe der Schale	Bobina / Roll Bobine / Rolle		Tensione Voltage Tension Spannung	Potenza Power Puissance Leistung	Peso Weight Poids Gewicht
						Larghezza Width Largeur Breite	Ø max. Max. Ø Ø max. Max. Ø			
TVG-SAP	600 mm	900 mm	1270 mm	380 mm x 280 mm	115 mm	420 mm	250 mm	230V~	1400 W	kg 104

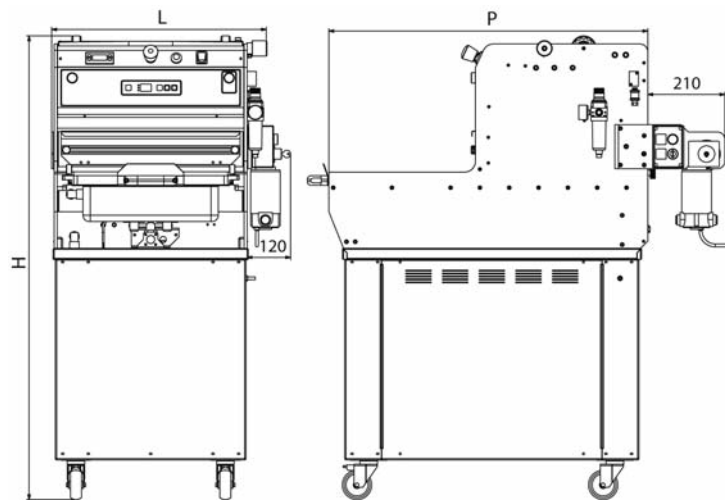

Modello Model Modèle Modell	Larghezza Width Largeur Breite	Profondità Depth Profondeur Tiefe	Altezza Height Hauteur Höhe	Impronta max. stampo Max. impression of the die Empreinte max. sur l'outillage Max. Abdruck Siegelform	Altezza max. vaschetta Max. height of the cup Hauteur max. de la barquette Max. Höhe der Schale	Bobina / Roll Bobine / Rolle		Pompa vuoto Vacuum pump Pompe à vide Vakuumpumpe	Tensione Voltage Tension Spannung	Potenza Power Puissance Leistung	Peso Weight Poids Gewicht
						Larghezza Width Largeur Breite	Ø max. Max. Ø Ø max. Max. Ø				
TVG 20	600 mm	900 mm	1270 mm	380 mm x 280 mm	115 mm	380 mm	250 mm	20 m³/h	230V~	2200 W	kg 139
TVG 25	600 mm	900 mm	1270 mm	380 mm x 280 mm	115 mm	380 mm	250 mm	25 m³/h	230V~	2400 W	kg 172
TVG 40	600 mm	900 mm	1270 mm	380 mm x 280 mm	115 mm	380 mm	250 mm	40 m³/h	230V 3~ / 400V 3N~	3100 W	kg 145
TVG 60	600 mm	900 mm	1270 mm	380 mm x 280 mm	115 mm	380 mm	250 mm	60 m³/h	230V 3~ / 400V 3N~	3800 W	kg 157

VALKO®

VALKO srl
Via Berlino, 1
24040 Bottanuco
(Bergamo) Italy

▪ **Phone**
+39.035.4992010
Fax
+39.035.4992015

▪ www.valko.com
info@valko.com

Made in Italy



Le fotografie rappresentate contengono optional.
Pictures with accessories.
Les photos représentées sont avec des options.
Photos mit Zubehören.

La ditta VALKO si riserva il diritto di apportare qualsiasi modifica per il miglioramento delle sue apparecchiature.
VALKO reserves the right to change its equipment in order to improve it.
Document non contractuel. La VALKO pratique une politique d'amélioration permanente et se réserve le droit de
modifier ses appareils sans notification préalable.
Änderungen für Verbesserungen vorbehalten.